

Step1

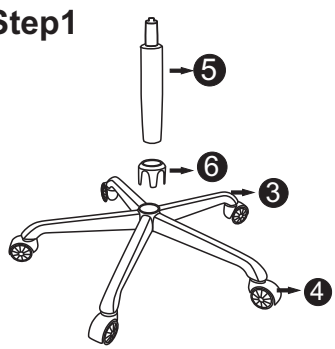

Step2

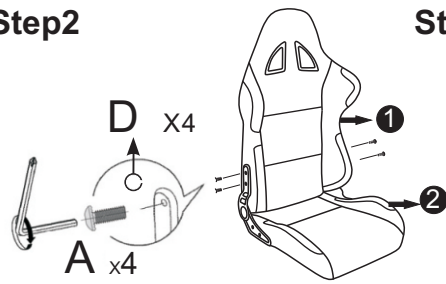

Step3

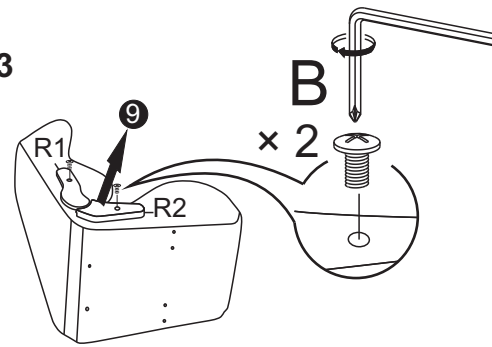

Step4

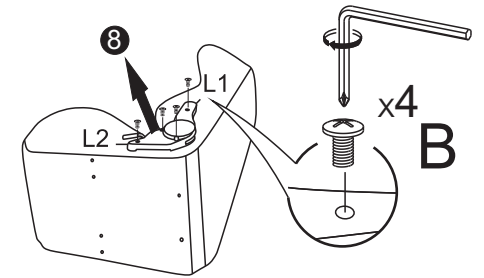

Step5

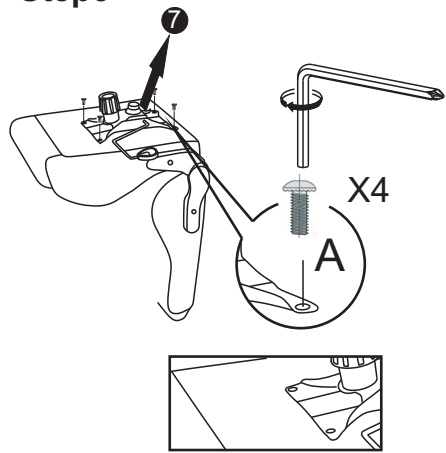

Step6

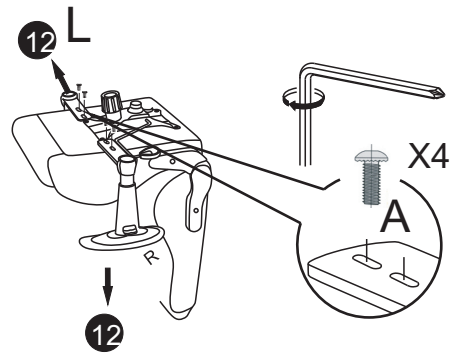



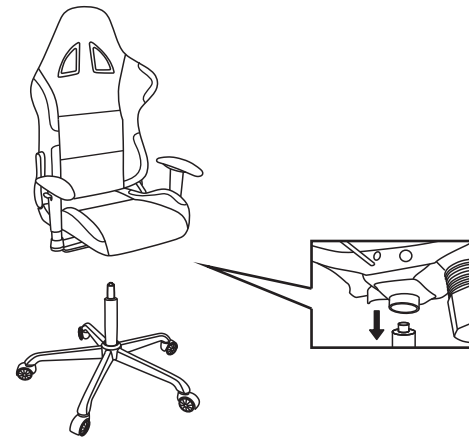



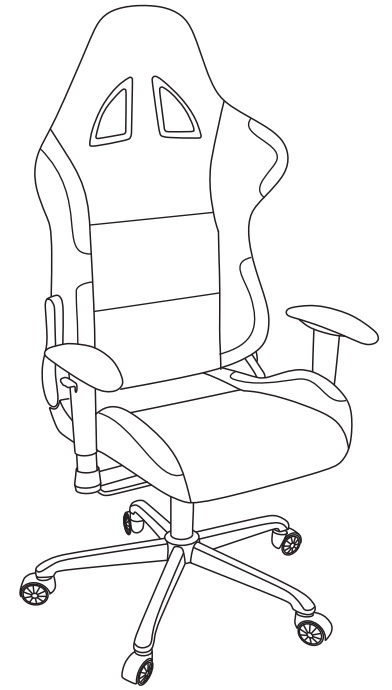

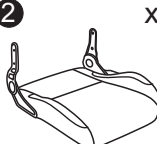
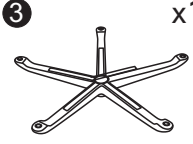
Step7

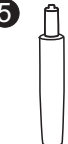
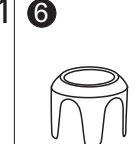

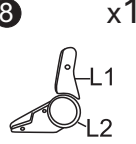
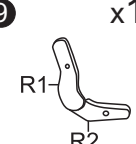
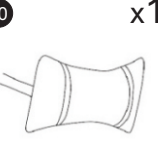
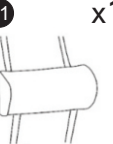
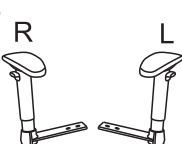
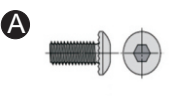
Step8



 x1	 x1	 x1	 x5	 x1	 x1	 x1	 x1	 x1	 x1	 x1	 x1
 x12 M8X20mm	 x6 M4X6mm		 x4 M8								